

Reactive Power Control Relay RM 9606

Operating Instructions



Fig. 1: View of Front Panel

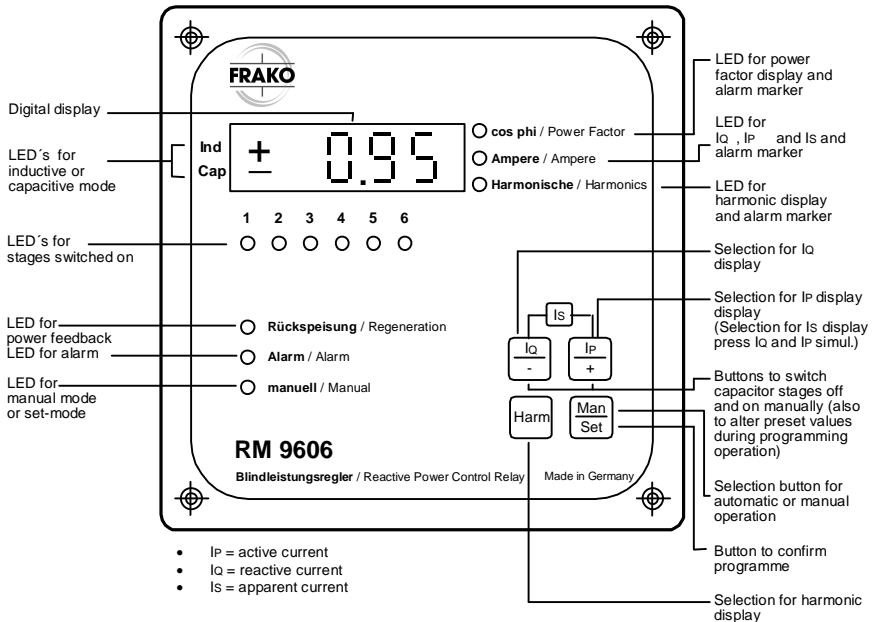

Figure 1: View of Front Panel

View from below

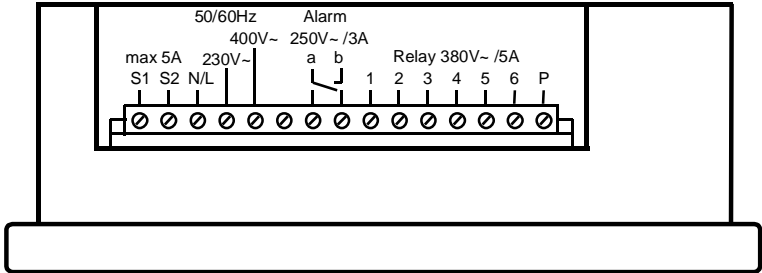

Figure 2: View from below

Contents	Page
1. Summary of Instructions.....	7
2. Functions	8
2.1 Automatic Identification of Voltage and Current Source.....	8
2.2 Automatic Identification of the Connected Capacitor Stages.....	8
2.3 Automatic Setting of Switching Time Delay	9
2.4 Power Feedback.....	9
3. Installation and Connection.....	10
3.1 Installation	10
3.2 Voltage Connection.....	10
3.3 Current Transformer Connection.	11
3.4 Alarm Contacts.....	11
3.5 Control Contacts.....	12
3.6 Additional Instructions.....	12
4. Commissioning.....	13
4.1 First Commissioning	13
4.2 Renewed Commissioning.....	13
5. Programming (Set)	14
5.1 Setting of Target Power Factor....	19
5.2 Parallel Shift (PS)	20
5.3 Limitation (L)	20
5.4 Switching Time Delay	22
5.5 Automatic Stage Current (c/k) Identification "ON/OFF"	22
5.6 Response Current (c/k)	23
5.7 Switching Sequence	25
5.8 Number of Contactors used.....	25
5.9 Specifying fixed Stages	26
5.10 ON/OFF Connection Identification.....	26
5.11 Connection Mode	26
5.12 Setting Capacitor Discharge Time.....	26
5.13 Setting Cyclic/ Non-Cyclic Switching Rotation.....	26
5.14 Setting Threshold for Number of Switchings Alarm	26
5.15 Resetting Switching Counter.....	27
5.16 Current Transformer (CT) Ratio.....	27
5.17 Voltage Transformer Ratio.....	27
5.18 Setting 5 th Harmonic Threshold.....	27
5.19 Setting 7 th Harmonic Threshold.....	27
5.20 Setting 11 th Harmonic Threshold.....	28
5.21 Setting 13 th Harmonic Threshold.....	28
5.22 Harmonic Over-Current Alarm Signal.....	28
5.23 Suppressing the Power Factor Alarm.....	28
5.24 Total kvar Display.....	28
6. Operation.....	29
6.1 Modes of Display.....	29
6.2 Manual Operation	30
6.3 Alarms	31
7. Technical Data.....	33
8. Trouble-Shooting	35

Safety and Warning Instructions!!

!!! Important, read before commissioning !!!

- The user must make sure that every person handling this unit must know these operating instructions and handle the unit accordingly.
- These operating instructions must be read thoroughly before the unit is installed and commissioned.
- Proceed only according to these operating instructions.
- Only trained personnel should install and commission this unit. Specific rules and regulations must be observed.
- The unit is under power and must not be opened.
- If the unit is visibly damaged it must not be installed, connected and commissioned.
- Disconnect the unit immediately if it does not operate after commissioning.
- Do observe all laws and regulations concerning this product.

Additionally all safety and commissioning instructions of the Reactive Power Control System are to be observed.

Do not hesitate to contact ZavoshElectric.ir if you have any questions

EG-Konformitätserklärung

Declaration of Conformity



Dokument-Nr.: EG-RM9606-101A / 02.2003

Wir/We **FRAKO Kondensatoren- und Anlagenbau GmbH**
Techeulinstraße 21 a
79331 Teningen
GERMANY

erklären in alleiniger Verantwortung, daß das Produkt
declare under our sole responsibility that the product

Produktbezeichnung: **Bindleistungsregler RM 9606**
name of product **Power Factor Control Relay RM 9606**

Typenreihe: **RM 9606** ab Fert.-Nr. 002000
family **from Ser. No.**

auf das sich diese Erklärung bezieht, mit der/den folgenden Norm(en) oder normativen Dokument(en)
to which this declaration relates is in conformity with the following standard(s) or other normative document(s):

- | | | | |
|----|-------------|-------|--|
| 1. | EN 50 081-1 | 01.92 | EMV, Fachgrundnorm Störaussendung Wohnbereich |
| | EN 50 081-2 | 08.93 | EMV, Fachgrundnorm Störaussendung Industriebereich |
| | EN 50 082-1 | 03.93 | EMV, Fachgrundnorm Störfestigkeit Wohnbereich |
| | EN 50 082-2 | 01.93 | EMV, Fachgrundnorm Störfestigkeit Industriebereich |

gemäß der Bestimmungen der Richtlinien
following the provisions of Directive

89/336/EWG	Elektromagnetische Verträglichkeit / Electromagnetic Compatibility Directive
92/31/EWG	Anderung der Richtlinie 89/336/EWG / Modification of 89/336/EEC
93/68/EWG	Anderung der Richtlinien 89/336/EWG / Modification of 89/336/EEC

- | | | | |
|----|-------------|------|--|
| 2. | EN 61 010-1 | 1993 | Sicherheitsbestimmungen für elektrische Meß-, Steuer-,
Regel- und Laborgeräte |
|----|-------------|------|--|

gemäß der Bestimmungen der Richtlinien
following the provisions of Directive

73/23/EWG	Niederspannungsrichtlinie / Low Voltage Directive
-----------	---

Teningen, den 05.02.2003

P. Herbst / H.-G. Mail

Diese Erklärung bescheinigt die Übereinstimmung mit den genannten Richtlinien, beinhaltet jedoch keine Zusicherung von Eigenschaften. Die Sicherheitshinweise der mitgelieferten Produktdokumentation sind zu beachten.
This declaration certifies the conformity according to the mentioned directives, without any assurance of features. Please note the safety instructions of the attached product documentation.

1. Summary of Instructions

On delivery, the control relay is set to pre-programmed standard values.

(see Table 1, pages 15 to 17)

The Reactive Power Control Relay RM 9606 is self-regulating (i.e. it detects and adjusts to the voltage phase connection, frequency and the response current (c/k ratio) automatically).

Before a reactive power control system can be put into operation, the target power factor has to be programmed.

How to programme the Control Relay:

- a) The control relay should be connected as shown in (see page 11).
- b)) Apply voltage to the control relay: "---" appears on the digital display. The control relay now identifies the location of the current and voltage source. This process takes at least 2 minutes and a maximum of 15 minutes. The power factor is displayed. (If this is not the case, see section 8. page 35).
- c) Press the "Set" button for 8 seconds. "-01-" will appear on the digital display and the "manual" LED flashes.
- d) By repressing the "Set" button the target power factor is displayed. If necessary, reprogramme to the nearest higher or lower value by pressing either the "+" or "-" button until the reprogrammed target power factor is displayed.

If no numbers appear on the display then the control relay must be briefly disconnected from the voltage source and the "Set" button has to be pressed again according to c).

- e) To confirm the value press the "Set" button again. "-02-" will appear on the display.
- f) Now press the "-" button twice until "END" appears on the display. Store this value by pressing the "Set" button. The target power factor is now stored permanently.

To display the correct values for power and current, enter the current and voltage transformer ratios

(see sections 5.16 and 5.17).

To prevent unintentional reprogramming, the set mode can only be activated within the first 5 minutes after the operating voltage has been applied. If the set mode has been activated within the first 5 minutes, you have one hour to complete the programming. In order to obtain the set mode again after this period of time the control relay must be briefly disconnected from the voltage source.

On pages 15 - 17 all other preprogrammed standard values and their programme ranges are listed. The function of the programmed standard values is described section 5.

2. Functions

The reactive power and active power portions of the power source are continuously calculated in the control relay from the measured voltage and the signals of the current transformer. If the reactive power portion exceeds certain threshold values, which the control relay has measured at the time of auto-adaptation or are set as per section 5, a switching action will take place at the switching outputs.

In the case of inductive reactive current (inductive reactive power) one or more control contacts of the reactive power control relay are closed after the preprogrammed time delay.

This causes the RM 9606 to switch capacitor stages onto the power source supply, as and when required, in order to achieve the programmed target power factor. If the inductive reactive current portion of the load is reduced, the excess of reactive current causes the capacitor stages to be switched off line.

The Control Relay RM 9606 allows a variety of possible settings to meet the conditions on site. The relay's cyclic operations prolong the life of all connected devices by averaging the length of time the capacitor stages are switched on. An effective supervision of the reactive power control system (capacitor bank) is secured by the power factor display.

2.1 Automatic Identification of Voltage and Current Source

When voltage is initially applied to the control relay, it determines the location of the current and voltage sources (automatic phase rotation), i.e. it identifies in which phase and at which phase angle the current path and the voltage path are connected. Should the control relay fail to identify the current and voltage source due to power instabilities, repeat the procedure when the power has stabilized. It is also possible to programme the phasing manually (see sections 5.10 and 5.11).

Resetting of the control relay and re-identification of voltage and current sources is initiated by pressing buttons "+" and "Set" simultaneously for at least 8 seconds.

2.2 Automatic Identification of the Connected Capacitor Stages

Having determined the voltage and current source identification, the RM 9606 automatically calculates the c/k identification. During the identification process all the control contacts of the relay are individually switched on and off again. The stage currents ascertained are then stored. These values determine the stage sequence. In this way it can also be determined which switching outputs are in

The processes of automatic identification of voltage and current source and/or the automatic identification of capacitor stages are only carried out when switching on or pressing the combination of buttons "+", "-", and "Set" for min. 8 seconds.

(see section 2.1)

Precondition: The automatic identification mode or the automatic identification of connected capacitor stages mode are switched to "ON".

The RM 9606 checks stored stage currents at specific time intervals during normal operation. If it recognises that a capacitor stage has failed, this stage (stage without capacitance) will be ignored in future normal operations.

All failed stages are switched on from time to time in order to re-check their capacitance. If a capacitor stage is added later on, or defective fuses are exchanged, the RM 9606 itself identifies this after some time and the stage is then reintegrated into the normal operation. However, we recommend that if capacitor stages are added at a later date, the set-up procedure be repeated (see section 2.1).

Do not hesitate to contact ZavoshElectric.ir if you have any questions

Note:

In case of low voltage networks being fed by several transformers switched in parallel, the capacitor current is distributed to all the transformers. If measurements are **not** carried out via a summation transformer, the current change, measured by the control relay, is too low when switching on the capacitor stages, which can lead to errors during the automatic stage identification process. In such situations we recommend that the stage identification be switched off and the relevant values be programmed manually. (see sections 5.5 to 5.8)

2.3 Automatic Setting of Switching Time Delay

In order to keep the wear of the capacitor's contactors down to a minimum the response time of the control relay is lengthened or shortened automatically according to the frequency of the change of the load.

2.4 Power Feedback

The RM 9606 is equipped with a four quadrant control. This means that even when active power is fed back into the mains, the control relay ensures compensation for the reactive power which has been drawn from the mains. In this case the LED "Regeneration" lights up.

3. Installation and Connection

The Reactive Power Control RM 9606 automatically determines the location of the current and voltage sources (automatic phase rotation). It may be connected either to two phases (phase / phase) or to one phase and neutral (phase/neutral). The current transformer can be installed in any phase. It has to be passed by both capacitor and consumer current.



IMPORTANT NOTICE:

During installation and service work the control relay must be kept free of voltage.

3.1 Installation

Individually supplied control relays are provided with insulated fixing screws. These can be used to install the control relay into switchgear cabinets of cubicles of protective class II. Furthermore a sealing ring is supplied, which must be used when installing the control relay in switchgear cabinets and cubicles of protection class IP 54.

The pre-mounted terminal connections allow a quick and easy installation. The control relay is electrically connected through a multiple connecting terminal supplied with the relay.

3.2 Voltage Connection

The control relay should preferably be connected to the three-phase system as shown in (page 11). To keep the function "Zero Voltage Alarm" operational the supply voltage of the control relay should be connected in the same phase as the contactor voltage.

Supply voltage of 230 V should be connected between the terminals "N/L" and "230V". Supply voltage of 400V should be connected at the terminals "N/L" and "400V".



IMPORTANT NOTICE:

The control relay is designed for a mains voltage of 230 VAC or 400 VAC (phase/neutral or phase/phase).

For voltages greater or equal to 400 V, a control transformer for the supply of the controller must be used.

It is not allowed to use both connecting terminals "230V" and "400V" simultaneously.

The connection of the supply voltage must be fused externally with max 4A.

Figure 3: Circuit Diagram

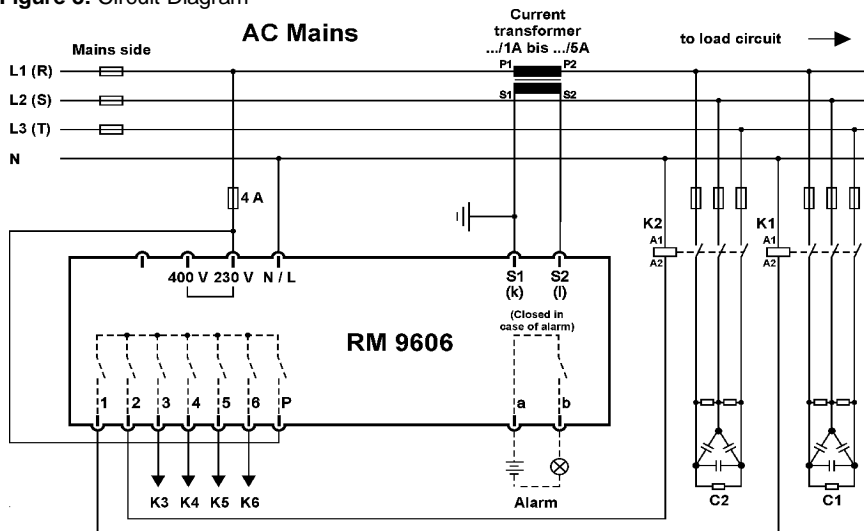

3.3 Current Transformer Connection

The outputs S1 and S2 of the current transformer are connected to the terminals S1 and S2 of the control relay. In order to keep the load on the current transformer as low as possible the supply lines should have a cross-section area of 2.5 mm².



ATTENTION:

The rated current in the current transformer path should not exceed 5 Amps.

Notice:

After connection the short-circuiting bridge might have to be removed from the current transformer. Do not hesitate to contact ZavoshElectric.ir if you have any questions

3.4 Alarm Contacts

A potential-free alarm signal contact is accessible on the terminals "a" and "b". The contact closes when either there is no mains voltage applied to the control relay or when an alarm is signalled. (section 6.3)

When there is an alarm signal, the LED "alarm" lights up and the relevant LED begins to flash on the control relay.



IMPORTANT NOTICE:

It must not be possible to touch the applied voltage at the alarm contact. If this cannot be achieved the voltage must be earthed, even if it is only small protective voltage.

The maximum load for the alarm contact is 250 VAC and 3 Amps.

3.5 Control Contacts

The control voltage of the contactors should be connected to the terminals "PI" and "PII". These circuits are potential free.



IMPORTANT NOTICE:

In order not to overload the control contacts the sum of the holding currents of all contactor coils connected may not exceed a value of 5 Amps.

The max. load of the switching contacts is 380 VAC.

In order to maintain the function of the undervoltage monitoring it is absolutely necessary to make sure that the control voltage of the contactors is in the same phase as the control relay supply.

3.6 Additional Instructions

The installation and connection of the RM 9606 is only finished, once it has been installed and wired according to these instructions.



IMPORTANT NOTICE:

Before commissioning of the control relay it has to be ascertained that it is not possible to touch the connecting terminals (e.g. by means of a locked door or covering).

The control relay must be kept voltage free during wiring and installation works.

4. Commissioning

After the control relay has been installed as described in section 3, the relay can be put into operation.

4.1 First Commissioning

When the control relay is put into operation for the first time it tries to determine the mode of connection and the size of the stages. The display shows "---" and after a discharge time for the capacitors the stages are switched on and off again one after the other. This process can take up to 15 minutes.



ATTENTION:

If the RM 9606 does not act as described above, remove voltage source and check installation.

If the identification process is not concluded within 15 minutes there is probably a fault. (See section 8, page 35)

Notice:

In order for the relay to be able to determine the mode of connection at least one capacitor stage must be operational.

Possibly the control relay has already been used before and acts as described in section 4.2.

It is also possible to discontinue the identification process by switching off the automatic connection and stage current identifications. This takes place in set mode and at the same time it is necessary to programme the connection and stage parameters manually (see section 5).

After the identification process the actual power factor appears on the display and the control relay begins to function.

If the power factor shown does not coincide with the real power factor, the identification process must be repeated.

This can be done by pressing the buttons "+", "-" and "Set" simultaneously for at least 8 seconds.

4.2 Renewed Commissioning

After a mains failure the control relay immediately starts the normal control programme again. The data which were determined whilst being put into operation for the first time are stored in a non-volatile memory.

By pressing the buttons "+", "-" and "Set" simultaneously for a least 8 seconds these data are erased from the memory and the control relay again begins to determine the mode of connection and the size of stages.

It is assumed that the automatic connection and stage current identification are switched on (see section 5).

5. Programming (Set)

In order to permit the widest possible use of the control relay, multiple settings are available. To simplify matters, the control relay is set to standard values in our factory before delivery.

(see Table 1, pages 15 to 17)

The user only needs to change the target power factor or a few values to suit his special requirements. As a protection against unintentional reprogramming, the set mode (programming mode) can be invoked only within 5 minutes after operating voltage is applied. After this period the values can only be read (read-only mode). If the set mode has been activated within these 5 minutes, it remains available for one hour. In order to reach the set mode again after this period, it is necessary to disconnect the control relay from its source for a short period of time.

The procedure for checking or reprogramming the set values is as follows:



- Press the "man/set" button for at least eight seconds to switch to the set mode. The display then shows "-01-". This number corresponds to the first variable which is displayed or can be changed in the following sequence (see Table 1).

- The actual value appears on the display when the "man/set" is pressed again.
- By pressing the "+" or "-" button the next higher or lower setting can be attained. *The control relay is in the read-only mode if above is not possible. To reach the set mode again, the control relay must be disconnected from its source for a short period of time.*
- Press the "man/set" button repeatedly; the mode numbers appear followed by the programmed value (see Table 1).
- If the "+" is pressed again after mode number "-24-" appears on the display, or if the "-" is pressed again after mode number "-01-" appears on the display, then the display will show "End".
- By confirming the display "End" by pressing the "man/Set" button the control relay assumes normal operation; the preset values are then permanently stored in a non-volatile memory.

Notice:

During the "set mode" none of the capacitor stages is changed and there is no switching of the alarm contact.

Table 1: Programming of Values

Programme Mode No.	Description	Pre-programmed standard Value	Programme Range
-01-	Target Power Factor	Ind. 0.92	from cap. 0.90 to ind. 0.8 in increments of 0.01 steps
-02-	Parallel Shift PS	-1.0 (Target Power Factor is lower than limit value)	from -2 to +4 in increments of 0.5 steps
-03-	Limitation L	+1.0 (Overcompensation is avoided)	from -2 to +2 in increments of 0.5 steps
-04-	Switching time delay in seconds	45	5 to 500 seconds in 1 sec. steps or at a high speed in 5 sec.steps.*)
-05-	Automatic c/k Identification	ON	ON=automatic mode OFF=manual mode When "ON", the programme switches directly to programme mode no. -09-
-06-	Manual c/k Value setting	2.0	From 0.02 to 2.0 in 0.01 steps or At high speed in 0.05 steps.*)
-07-	Switching sequence	1:1:1:1:1	1:1:1:1:1:1 1:1:2:4:4:4 1:2:3:4:4:4 1:1:2:2:2:2 1:1:2:4:8:8 1:2:3:6:6:6 1:1:2:2:4:4 1:2:2:2:2:2 1:2:4:4:4:4 1:1:2:3:3:3 1:2:3:3:3:3 1:2:4:8:8:8
-08-	Number of contactors used	6	From 1 to 6
-09-	Determination of Fixed stages	0	0= no fixed stage 1= output fixed 2= outputs 1 and 2 fixed 3= outputs 1 to 3 fixed

*) by pressing the buttons "+" or "-" for some time, the high speed mode will be active

Table 1 Programming of Values

Programme Mode No.	Description	Pre-programmed standard Value	Programme Range
-10-	Automatic identification of voltage and current source	ON	ON= automatic OFF= manual When "ON", mode -11- can only be read but not changed.
-11-	Enter or read mode of connection	Automatic identification	See Table 2
-12-	Switching-off time	60	From 5 to 900 seconds. *)
-13-	Setting cyclic / non-cyclic switching rotation	ON	ON= cyclic switching OFF= non-cyclic switching
-14-	Threshold for number of switching alarm	OFF	From OFF to 1000 the value must be entered in x1000 switches
-15-	Cancelling individual switching counters	0	Enter a number of 1-6. When leaving this menu point the counter of the corresponding capacitor stage will be set to 0. Point "ALL" will reset all counters to 0.
-16-	Current transformer Ratio	1	From 1 to 7000 in steps of 1 or at high speed in steps of 5.*)
-17-	voltage transformer ratio	1	From 1 to 300 in steps of 1 or at high speed in steps of 5.*)

*) by pressing the buttons "+" or "-" for some time, the high speed mode will be activated.

Table 1 Programming of Values

Programme Mode No.	Description	Pre-programmed standard Value	Programme Range
-18-	5 th harmonic threshold in %	5	From 1 to 20 % in 0.1 % steps or 0.5 % steps at high speed.*)
-19-	7 th harmonic threshold in %	4	From 1 to 20 % in 0.1 % steps or 0.5 % steps at high speed.*)
-20-	11 th harmonic threshold in %	3	From 1 to 20 % in 0.1 % steps or 0.5 % steps at high speed.*)
-21-	13 th harmonic threshold in %	2.1	From 1 to 20 % in 0.1 % steps or 0.5 % steps at high speed.*)
-22-	Harmonic over-current	1.3	From 1.05 to 3.0 times the nominal value in 0.05 steps or 0.1 increments at high speed
-23-	Power factor alarm tripping signal	ON	ON or OFF By setting "OFF" a power factor alarm can be suppressed.
-24-	Total kvar display	Will only be displayed when in operation	By pressing "set" button the total power in kvar will be displayed.

*) by pressing the buttons "+" or "-" for some time, the high speed mode will be activated.

If the current transformer is installed in correct direction and the connections S1(k) and S2(l) are correctly connected with the control relay, the following kinds of **Connection modes** are valid:

Connection mode	Connection at the voltage path		
	L/N – L	L/N – L	L/N – L
0	L1 – N	L2 – N	L3 – N
1	L1 – L3	L2 – L1	L3 – L2
2	N – L3	N – L1	N – L2
3	L2 – L3	L3 – L1	L1 – L2
4	L2 – N	L3 – N	L1 – N
5	L2 – L1	L3 – L2	L1 – L3
6	N – L1	N – L2	N – L3
7	L3 – L1	L1 – L2	L2 – L3
8	L3 – N	L1 – N	L2 – N
9	L3 – L2	L1 – L3	L2 – L1
10	N – L2	N – L3	N – L1
11	L1 – L2	L2 – L3	L3 – L1
CT Location in phase:	↑ L1	↑ L2	↑ L3

Table 2: **Connection mode**

Note:

If S1(k) and S2(l) are connected the wrong way around or the CT is installed in wrong direction, connection mode number must be added by 6. If the result is higher than 11, 12 must be subtracted. The result corresponds to the connection mode number which have to be entered.

5.1 Setting of Target Power Factor

The desired target power factor can be set from cap. 0.9 to ind. 0.8 in 0.01 steps.

The mode of operation of this adjustment can be seen in Figure 4 and Figure 5.

If the control relay operates within the band range shown no switching operations will be activated.

However, if the control relay operates outside the band range, the RM 9606 will try to come within the band range with the minimum of switchings.

Figure 4: Control response after setting target power factor = 1; L = OFF; PS = 0

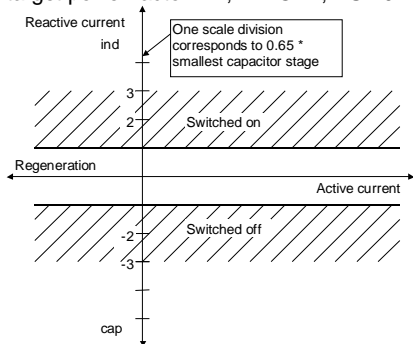
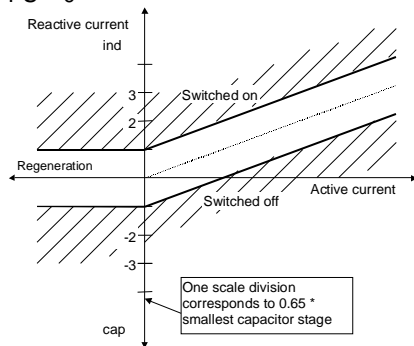

Figure 5: Control response after setting target power factor = 0.92 ind; L = OFF; PS = 0



In Figure 5 the behaviour of the control relay during feedback operation can also be seen. The "kink" in the band (characteristic line) is not reflected in the feedback operation but is extended at the point of intersection of the reactive power centre line (axis) with the feedback operation line.

By shifting the band into the capacitive range (see Figure 7 in section 5.2) the occurrence of an inductive reactive power during the feedback operation can be virtually avoided.

When a capacitive target power factor mode is set, the control band is reflected from the supply side to the feedback side. (see Figure 10).

5.2 Parallel Shift (PS)

This setting causes a parallel shift of the band range as shown in Figure 4 by the set value.

It will shift to the inductive direction if the plus sign is used and to the capacitive direction if the minus sign is used.

The values -2 to +4 can be set in 0.5 steps. The effects are illustrated by the two examples in Figure 6 and Figure 7.

Figure 6: Control response after setting target power factor = 1; L = OFF; PS = +1.0

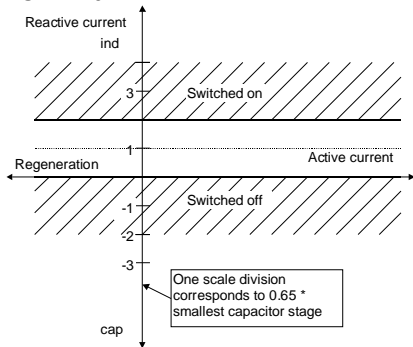

The set target power factor is therefore the upper limit of the control band.

Figure 7: Control response after setting target power factor = 0.92 ind; L = OFF; PS = -1.0

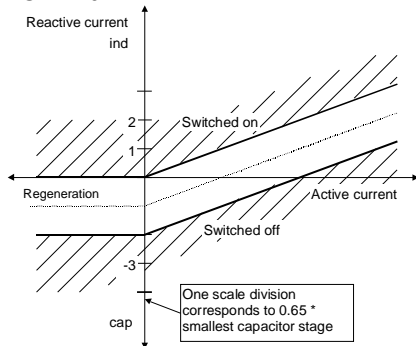

The set target power factor is the lower limit of the control band range.

(This is the recommended setting when using asynchronous generators in parallel.)

5.3 Limitation (L)

This setting gives new possibilities that could not be attained before due to opposing requirements.

The range of values for L are -2 to +2 in steps of 0.5 and the setting "OFF". Setting the limitation value of 1 and a target power factor of 1.0 has the same effect as the parallel shift. For a target power factor other than 1.0 there is a "kinked" characteristic as shown in Figure 8.

The limitation therefore specifies an absolute reactive power limit, below which the control band does not go.

Figure 8: Control response after setting target power factor = 0.92 ind; PS = 0; L = +1.0

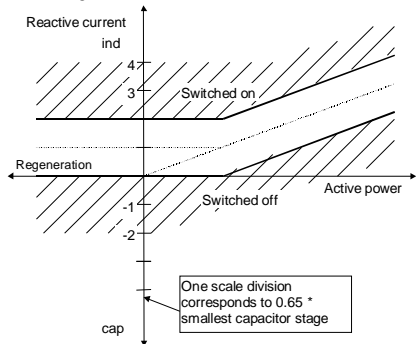

This setting has the following effects:

- The power factor is attained, on the average, in the "upper" power range.
- Over-compensation (capacitive load) is avoided in the low load range.

An appropriate combination of "parallel shift" and "limitation" is illustrated in Figure 9.

Figure 9: Control response after setting target power factor = 0.92 ind; PS = -1.0; L = +1.0

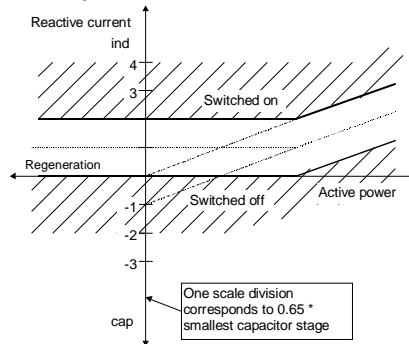

This example illustrates:

- In the "upper" power range the set power factor is specified as the lower limit value.
- Over-compensation is avoided in the low load range.

This setting is the normal setting on delivery from the factory and represents the best possible control characteristic for most applications.

The following Figure 10 shows the characteristics of the control band when set for a capacitive target power factor. In

this case the control range is not prolonged at the reactive power axis into the feed back side, but is mirrored from the supply side into the feedback side.

Figure 10: Control response after setting target power factor = 0.95 cap; L = 1.0; PS = 0

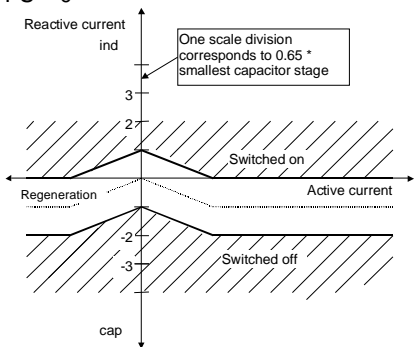

5.4 Switching Time Delay

The switching time delay period can be set between the values of 5 to 500 seconds in 5 second steps. When a capacitor stage is switched on or off the control relay waits for the switching time delay before the switching process takes place. If more stages are required the switching time delay is shortened depending on the number of stages required.

For example:

2 stages required = switching time delay /2
(reduced by one-half) or
3 stages required = switching time delay /3
(reduced by two-thirds).

In order to keep the wear on the contacts to a minimum, the switching delay time should be set to less than 45 seconds only in exceptional cases. The discharge period, which ensures that the capacitors are fully discharged before they are switched on again, overrides the switching delay time (see section 5.12).

5.5 Automatic Stage Current (c/k) Identification "ON/OFF"

The RM 9606 has an automatic c/k identification, i.e. it calculates the appropriate response current the first time the control relay is energized. This procedure is repeated until the amount of capacitive power for each stage is determined and the c/k value has been calculated. The automatic c/k identification feature can be set to "ON" or "OFF".

When "ON" the RM 9606 operates with the stage currents automatically calculated.

When "OFF" the c/k value must be programmed manually (under programme mode 6) according to Table 3 on page 24 or according to the Equation 1. Also programme modes 7 (switching sequence) and 8 (number of contactors used) have to be entered manually.

5.6 Response Current (c/k)

The Control Relay RM 9606 calculates a control characteristic from the power factor, the parallel shift and the limitation (in Figure 4 to Figure 10 shown as a dotted line) and has a tolerance band of 0.65 times the smallest stage in inductive as well as in capacitive direction (marked with bold line). The control relay consistently achieves this control band by switching on and off systematically. It is assumed that the connected capacitor-stages are sufficiently dimensioned.

The response current corresponds to half the width of the tolerance band, within which the reactive current can change without capacitor stages being switched on or off.

This is essential to ensure that the system does not oscillate. The total width of the tolerance band is selected in such a way that it corresponds to approx. 1.3 times the reactive current of the smallest capacitor stage.

When setting the automatic stage current identification to "OFF" the response current can be set between 0.02 and 2.0 A in steps of 0.01 A. The correct setting for a 400 V voltage system and a current transformer with 5A secondary current can be taken from Table 3.

In the case of other voltages or current transformers for which the primary or secondary current is not given, the response current can be calculated from the general equation:

Equation 1:

$$c/k = 0.65 \times \frac{Q}{U \times \sqrt{3} \times k} \approx 0.375 \times \frac{Q}{U \times k}$$

c/k = response current (Amps) to be set

Q = **capacitor stage rating in var of the smallest stage** (not the complete system)

U = mains voltage (V) on the primary side of the current transformer

k = transformer ratio
(primary /secondary current)

Table 3: Response Current at 400V mains voltage (c/k value)

c/k-adjustment for mains voltage 400 VAC, 50 Hz ~															
Current transformer	Stage rating of the smallest capacitor bank (not total rating) in kvar														
	A /A	2,5	5	6,25	7,5	10	12,5	15	20	25	30	40	50	60	100
30 /5	0,40	0,80	0,98	1,20	1,60										
40 /5	0,30	0,60	0,74	0,90	1,20	1,50									
50 /5	0,24	0,48	0,59	0,72	0,96	1,20	1,44								
60 /5	0,20	0,40	0,49	0,60	0,80	1,00	1,20	1,60							
75 /5	0,16	0,32	0,39	0,48	0,64	0,80	0,96	1,28	1,60	1,92					
100 /5	0,12	0,24	0,30	0,36	0,48	0,60	0,72	0,96	1,20	1,44	1,92				
150 /5	0,08	0,16	0,20	0,24	0,32	0,40	0,48	0,64	0,80	0,96	1,28	1,60	1,92		
200 /5	0,06	0,12	0,15	0,18	0,24	0,30	0,36	0,48	0,60	0,72	0,96	1,20	1,44		
250 /5	0,05	0,10	0,12	0,14	0,19	0,24	0,29	0,38	0,48	0,58	0,77	0,96	1,15	1,92	
300 /5	0,04	0,08	0,10	0,12	0,16	0,20	0,24	0,32	0,40	0,48	0,64	0,80	0,96	1,60	
400 /5	0,03	0,06	0,08	0,09	0,12	0,15	0,18	0,24	0,30	0,36	0,48	0,60	0,72	1,20	
500 /5	0,02	0,05	0,06	0,07	0,10	0,12	0,14	0,19	0,24	0,29	0,38	0,48	0,58	0,96	
600 /5		0,04	0,05	0,06	0,08	0,10	0,12	0,16	0,20	0,24	0,32	0,40	0,48	0,80	
750 /5		0,03	0,04	0,05	0,06	0,08	0,10	0,13	0,16	0,19	0,26	0,32	0,38	0,64	
1000 /5		0,02	0,03	0,04	0,05	0,06	0,07	0,10	0,12	0,14	0,19	0,24	0,29	0,48	
1500 /5			0,02	0,02	0,03	0,04	0,05	0,06	0,08	0,10	0,13	0,16	0,19	0,32	
2000 /5					0,02	0,03	0,04	0,05	0,06	0,07	0,10	0,12	0,14	0,24	
2500 /5						0,02	0,03	0,04	0,05	0,06	0,08	0,10	0,12	0,19	
3000 /5							0,02	0,03	0,04	0,05	0,06	0,08	0,10	0,16	
4000 /5								0,02	0,03	0,04	0,05	0,06	0,07	0,12	
5000 /5									0,02	0,03	0,04	0,05	0,06	0,10	
6000 /5										0,02	0,03	0,04	0,05	0,08	

If the size of the stage, the current transformer, or the rated current of the control system does not meet the values as given in above table, the equation on page 23 has to be applied in order to determine the c/k value.

5.7 Switching Sequence

When the automatic c/k identification is switched on every optional switching sequence is possible.

Necessary condition: When the optional switching combinations are sorted according to their capacity, the capacity difference between two successive combinations may only be 1.2 times the capacity of the smallest stage.

If the automatic c/k identification is switched off, the switching sequence (switching programme) can be reset to the following combinations of capacitor stages:

1:1:1:1:1:1	1:1:2:4:4:4	1:2:3:4:4:4
1:1:2:2:2:2	1:1:2:4:8:8	1:2:3:6:6:6
1:1:2:2:4:4	1:2:2:2:2:2	1:2:4:4:4:4
1:1:2:3:3:3	1:2:3:3:3:3	1:2:4:8:8:8

The smallest capacitor stage is always "1", the subsequent stages are either the same (1:1:1...) or are larger. In the second line above a more accurate result can be achieved with the same number of switching contactors.

When the automatic c/k identification is switched off, the smallest capacitor stage ("1") must be connected to the first control output of the connecting terminal. All other stages follow according to their capacity. In the case of fixed stages being used, the smallest stage has to be connected following the last fixed stage.

5.8 Number of Contactors used

When the automatic c/k identification is switched off, any value between 1 and 6 can be programmed. If, for example, there are five stages in a capacitor bank, these stages are connected to the control outputs "1" to "5" and the number of the control outputs is programmed to "5" in order to prevent the control relay from activating control outputs which have not been connected.

The size of the capacitor stages has no influence on this setting.

5.9 Specifying fixed Stages

The Control Relay RM 9606 allows the first three control outputs to be treated as fixed stages. Fixed stages are stages which are not included in the normal control cycle but are switched on immediately after the control relay is switched on and always remain switched on. The set discharge period is maintained. The target power factor setting is ignored.

The following settings are possible:

- 0 = no fixed stages
- 1 = control output 1 is fixed
- 2 = control outputs 1 and 2 are fixed
- 3 = control outputs 1 to 3 are fixed

The switching sequence does not take into account the fixed stages.

5.10 ON/OFF Connection Identification

The control relay has an automatic connection identification feature. (Refer to section 2.1)

ON: The connection recognised by the control relay can be read under mode number -15- in accordance with Table 2. (not changeable)

OFF: The connection must be manually programmed as per Table 2.

5.11 Connection Mode

Usually, the connection mode should be set to automatic operation. If, however, the control relay failed to determine the connection mode after 15 minutes due to high load changes or phase imbalances, it is possible to enter the connection mode manually as per Table 2.

5.12 Setting Capacitor Discharge Time

In order to ensure that after switching-off, a capacitor stage is not switched on again before the capacitor has been sufficiently discharged, the switch-off time can be adjusted to the specific needs (discharge mode).

The discharge time can be set between 5 and 900 seconds.

5.13 Setting Cyclic/Non-Cyclic Switching Rotation

In certain cases when there are filtered and non-filtered stages within one system, it is necessary to ensure that the control relay does not operate cyclically. For such applications this feature can be disabled. On and off have the following meanings:

ON: Small number of switches, cyclic switching is enabled on all levels.

OFF: No cyclic switching; the stages within each level are switched on.

5.14 Setting Threshold for Number of Switchings Alarm

In order to support the maintenance of the unit the RM 9606 provides an internal counter for each switching output. During manual operation the present count for each stage can be displayed. (see section 6.2).

If the maximum of switching actions is chosen the control relay displays the need for maintenance. The stage which has exceeded the limit (e.g. "51.4" for the 4th stage) flashes on the display (approx. every 10 seconds). At the same time an alarm is signalled. How to put out the alarm is explained in section 5.15.

The required number of switches is to be divided by 1000 before being entered. That means that entering 100 evokes an alarm at 100,000 switches of one stage.

The stage alarm signals have no influence on the control behaviour/ performance of the relay.

5.15 Resetting Switching Counter

In mode -15- the switching counters can be reset altogether or separately.

When choosing mode -15- the display shows "0". With the "+" and "-" buttons a stage number between 1 and 6 or "all" can be chosen. Leaving the programming section by pressing the "man/set" button resets the count of the displayed stage. By setting "all" all counts are reset.

If you do not want to reset any counter "0" has to be set before pressing the "man/set" button.

5.16 Current Transformer (CT) Ratio

In order to display the active current (IP), reactive current (IQ), and apparent current (IS) as actual values, the ratio between the primary current and the secondary current of the current transformer used must be entered. If the current transformer ratio is not set the value displayed must be multiplied by the CT ratio. Values between 1 and 7000 can be entered (eg. 1000A/5A→200).

5.17 Voltage Transformer Ratio

If a voltage transformer is used within the measuring circle the voltage transformer ratio must be entered in order to scale the display of missing kvar to reach the target power factor correctly.

The primary/secondary voltage transformer ratio is set between 1 and 300. If no voltage transformer is present, the value "1" must be entered.

5.18 Setting 5th Harmonic Threshold

The Control Relay RM 9606 has a harmonic monitoring system for the 5th, 7th, 11th, and 13th harmonics. If the limiting value is exceeded, there is an alarm signal, i.e. the alarm contact closes and the "Alarm" LED illuminates for as long as the limiting value is exceeded. The "Harmonic" LED flashes until the alarm is switched off. The order and the maximum value of the harmonics which have been exceeded, beginning with the maximum deviation, are displayed by multiple pressing of the "Set" button. The "Set" button must be pressed repeatedly until the "Harmonic" LED goes out.

5.19 Setting 7th Harmonic Threshold

Setting of the limiting value for the 7th harmonic.

5.20 Setting 11th Harmonic Threshold

Setting of the limiting value for the 11th harmonic.

5.21 Setting 13th Harmonic Threshold

Setting of the limiting value for the 13th harmonic.

5.22 Harmonic Over-Current Alarm Signal

The Control Relay RM 9606 is able to determine the ratio between the actually measured RMS current and the nominal current (50 - 60 Hz) of the capacitor. If this ratio is exceeded by the factor set for at least one minute due to harmonics and the resulting resonance phenomenon, the control relay switches off all stages which have been switched on. At the same time an alarm is signalled. After approximately four minutes the required capacitor stages are switched on again. By pressing the "Set" button the peak value is displayed.

Notice:

When exclusively filtered stages are being used, set this threshold to the highest possible value (in order to in-activate it).

5.23 Suppressing the Power Factor Alarm

As already described the control relay tries to reach its programmed control band. If this, however, is not possible due to lack of capacitor stages available, an alarm is signalled after several minutes (depending on the size of the difference). In case of a capacitive cos-phi outside the band range the alarm signal functions as well. When setting "OFF" the alarm is suppressed.

5.24 Total kvar Display

Provided the current transformer ratio has been entered, the total kvar detected at measured voltage will appear on the display, when "Set" is pressed in Mode -24-. Do not hesitate to contact ZavoshElectric.ir if you have any questions

6. Operation

6.1 Modes of Display

The power factor display is independent of the control relay operation and can be reprogrammed at any time. To the right of the four and a half character digital display there are three LEDs indicating which display mode is active, either "cos phi", "Ampere", or "Harmonic".

Five modes of display can be selected by pressing the appropriate button:

6.1.1 Power Factor

The "Power Factor" display mode is the standard display and can be activated from another mode of display by pressing the buttons "IQ", "IP", or "Harm".

The symbols "+" for ind. and "-" for cap. show whether the power factor is inductive or capacitive.

The LED "Regen" indicates that generative active power is fed back into the mains.

Active and reactive currents are measured separately. The power factor (cos phi) display value is the result of a mathematical calculation, which ensures accuracy over the entire range down to values close to 0. The minimum apparent current for a correct power factor (cos phi) display is approx. 0.02 A. When the apparent current falls below 0.02 A for three consecutive measurements one capacitor stage is

switched off and if there is no change in the measured current, all remaining stages are switched off and "I=0" appears on the display.

6.1.2 Reactive Current



The display indicates the reactive current portion in the current transformer circuit. The "+" for ind. or "-" for cap. indicate whether the reactive current is inductive or capacitive. The LED "Ampere" lights up. From this mode of display the compensation effect of the capacitor stages e.g. by adding or removing capacitor stages manually, can be monitored. If the current transformer ratio (CT) is programmed via the set mode, the actual reactive current on the primary side of the CT is displayed. Otherwise the current portion is displayed and has to be multiplied by the CT ratio to obtain the actual value.

Pres "IQ", "IP", or "Harm" buttons to exit this mode of display.

6.1.3 Active Current



The display shows the active current on the fundamental oscillation in the current transformer (CT) circuit. The LED "Ampere" lights up.

The current direction is also displayed which is helpful during tests. The LED "Regen" shows that the generative active power is fed back into the mains. If the CT ratio is programmed into the relay, the actual active current is displayed; otherwise the current portion is displayed and must be multiplied by the CT ratio to obtain the actual value.

Press "IQ", "IP", or "Harm" buttons to exit the display.

6.1.4 Apparent Current



Pressing the "IQ" and "IP" buttons simultaneously activates the display. The LED "Ampere" lights up. If the CT ratio is programmed into the relay, the actual apparent current on the fundamental oscillation in the current transformer (CT) circuit is displayed; otherwise the current

portion is displayed and must be multiplied by the CT ratio to obtain the actual value.

Press "IQ", "IP", or "Harm" buttons to exit the display.

6.1.5 Harmonics (5th - 13th)



This display shows the 5th, 7th, 11th, and 13th harmonics on voltage. The previous harmonic reading appears on the display (in %) and the LED "Harmonic" lights up. By pressing the "+" or "-" buttons several times the portions of the 5th, 7th, 11th, and 13th harmonics are subsequently displayed either in ascending or descending order.

For example, if "5. 2.9" is displayed this means "5th harmonics = 2.9 %".

Press the "Harm" button to exit the display.

6.2 Manual Operation



When the "man/Set" button is pressed for more than 3 secs, the control relay switches to manual operation and the LED "manual" begins to flash. The capacitor stages can be switched on or off by pressing the "+" or "-" button.

When the "+" button is pressed once, "1.ON" appears on the display until the control relay has switched on the first stage after approx. 10 secs provided no further buttons have been pressed. If the first stage was already switched on "1.OFF" will appear on the display until the control relay has switched off the first stage after approx. 10 secs. Then the display will change to the last displayed value.

While waiting the switching counter of this stage will be displayed for a short moment. The displayed value is multiplied by 0.001 and is indicated as far as possible as a decimal. That means for example:

"0.350" is equivalent to 350 switches.

By pressing the "+" button several times the stages 2 - 6 will appear in ascending sequence on the display. They can be switched on/off in the same way.

By pressing the "-" button once "6.ON" appears on the display until the control relay has switched on the 6th stage after approx. 10 secs. If the 6th stage was already switched on "6.OFF" will appear on the display until the control relay has switched off the 6th stage after approx. 10 secs. Then the display will change to the last displayed value. By pressing the "-" button several times the stages 5 - 1 will appear on the display in a descending sequence. They can be switched on/off in the same way.

In manual mode, the programmed switching off time (discharge time) is taken into consideration, i.e. when switching on a stage which was previously switched off the switching-off time is the same as the discharge time. If a stage was identified as a zero stage (without power) the corresponding numbers would indicate this by flashing.

Press "Man/Set" button to exit manual mode. Do not hesitate to contact ZavoshElectric.ir if you have any questions

6.3 Alarms

The potential-free alarm contact (a/ b) closes whenever the operating voltage is not applied. In the case of the correct operating voltage, the contact closes if there is an alarm. The conditions for an alarm can be seen in section 6.3.1 to 6.3.7 below. The LED "alarm" lights up for as long as a state of alarm exists. When an alarm is signalised, an alarm marker is put into action (LEDs "Power Factor", "Ampere", or "Harmonic" blink). The alarm markers remain active after the alarm until they are acknowledged by pressing the "Set" button. After acknowledgement the flashing alarm marker goes out. The alarm signals have no influence on the control behaviour/performs the relay.

6.3.1 Power Factor Alarm

If the threshold values set for "switch-on" and "switch-off" are exceeded and no further change can take place in the output stages, the alarm signal functions (except for the cos-phi alarm being switched-off; see mode -23-). By pressing the "Set" button the amount of capacitive and reactive power missing to reach the target power factor flashes on the display. Pressing the "Set" button again shows the actual power factor on the display and the alarm marker "Power Factor" no longer flashes.

6.3.2 Harmonic Alarm

When the programmed threshold values are exceeded the alarm goes off.

By pressing the "Set" button several times the display shows the order and the maximum values of the exceeded harmonics starting with the maximum deviation.

The button "Set" must be pressed repeatedly until the "Harmonic" alarm no longer flashes.

6.3.3 Over-current alarm

If the ratio between the actually measured RMS current and the nominal current of the capacitor has exceeded the programmed value for one minute, the alarm goes off and all stages are switched off.

After the alarm has been acknowledged it takes approx. 4 minutes until the necessary capacitor stages are switched on again.

By pressing the "Set" button the display shows the maximum value of the factor by which the RMS current has exceeded the nominal current.

By pressing the "Set" button again the display shows the actual power factor and the alarm marker "Ampere" no longer flashes. (See also section 5.23, page 28)

Notice:

The over-current ratio is a mathematically determined value and therefore cannot be applied to filtered systems.

6.3.4 Operating-Cycles Alarm

If a stage exceeds the set limit for number of operating cycles, the number of the stage that has exceeded the limit blinks in the display about every 10 seconds (e.g. "5.6" for the sixth stage). An alarm signal is also sent. Section 5.15 describes how this alarm signal is cancelled.

6.3.5 "U=0" Alarm

If there is an interruption in the measurement voltage path, the control relay switches off all stages after about 1 sec. and displays "U=0".

At the same time, the alarm contact closes and the "Alarm" LED lights up for as long as there is no voltage applied to the measurement input terminals of the control relay.

6.3.6 "C=0"-Alarm

If the relay does not identify a capacitor stage during the process of automatic terminal and stage current identification an alarm is signalled and the display shows "C=0".

The identification process is carried on despite the alarm. Do not hesitate to contact ZavoshElectric.ir if you have any questions

6.3.7 "I=0" Alarm

If there is an interruption in the current path for at least 3 secs., the control relay immediately switches off a capacitor stage.

If there is no change in the current as a result, the stages which are still on are switched off.

There is no alarm.

7. Technical Data

Mode of Connection:

Phase/Phase connection or

Phase/Neutral connection

Current via current transformer in optional phase (Figure 3, page 11).

Operating Voltage:

Supply voltage	Mains terminal voltage	Absolute permissible/threshold values
230V~/ 400V~	220V~ to 400V~	198V~ ... 440 V~

Attention: The terminals for 230V and 400V are internally bridged.

Frequency:

50 Hz / 60 Hz (48 to 62 Hz)

Consumption:

approx. 9-11VA at 0 to 6 switched-on control contacts

Current Path:

For current transformer .../1A~ to ... /5A~

Consumption in Current Path:

max. 1.8 VA at 5 A~ rated current of the CT

Control Contacts:

6 potential-free relay contacts

Loading Capacity of the Control

Contacts:

Switching voltage:

380 VAC (acc. to VDE 0110 part B)

250 VAC (acc. to VDE 0110 part C)

Switching current up to 5 A max.

Switching load up to 1800 VA max.

Fault Signal Contacts:

Loading capacity 250V~, 3A

No-Voltage Trip

(Undervoltage Monitoring):

For a voltage loss of longer than 15 ms all capacitor stages connected are switched off. After voltage is restored the control relay switches the required stages on.

Zero Current Trip:

For a current loss of longer than 3 secs capacitor stages connected are switched off. After current is restored the control relay switches the required stages on.

Operating Elements:

Foil keyboard with 4 buttons

LED Indicators:

12 LEDs

4 ½ character digital display

Temperature Range:

-20 °C to +60 °C

Enclosure Material:

Black synthetic plastic, flame resistant to UL-94, Class V0

Fastening:

Through the front panel by means of a screwdriver

Front Panel Dimensions:

144 x 144 mm (to DIN 43 700)

Panel Cut Out:

138 x 138 mm (to DIN 43 700)

Mounting Depth:

40 mm

Weight:

ca. 0.9 kg

Mounting Position:

as desired

Terminals:

Plug-in connector blocks
(supplied with the control relay)

Enclosure:

Terminals IP 20

Casing IP 54

(when using the sealing ring)

Design:

according to:

- EN 50 081-1

- EN 50 082-2

- EN 61 010

(VDE 0411 part 1) Protection Class II

(if insulated fixing screws are used)

Fusing:

External, max. 4A

8. Trouble-Shooting

Pos.	Faults	Possible Causes	Necessary Action
1	Control relay does not function, digital display remains blank.	There is either no voltage or the wrong voltage has been applied to the control relay.	Check whether the correct operating voltage is applied to the control relay.
2	U=0 flashes on the display.	The voltage applied to the voltage path of the control relay is too small.	Check the operating voltage. If the voltage is correct press the buttons "+", "-" and "Set" to recognise this voltage as rated voltage.
3	Relay does not respond to manual operation although it has voltage and digital display is operational.	End of delay time of approx. 10 secs. has not been observed.	For example , if "1. ON" appears on the display wait until the control relay has switched on the first stage.
		Relay was not in manual mode.	"Man" button must be pressed leading to flashing of the LED "manual".
4	Stage display (LED 1-6) lights up but capacitor contactors are not activated	Control circuit is not connected properly or there is no control voltage	Check the control circuit according to the circuit diagram and check fuses.
		There is no neutral on the contactors.	
5	Control relay does not complete the automatic identification procedure	Unstable power supply (power factor fluctuation).	Wait for power supply to stabilize or manually set c/k factor and mode of connection.
6	During automatic adjustment process "C=0" flashes on the display.	Fault in control circuit (contactors do not switch)	Check control circuit according to the circuit diagram; check fuses.
		Fuses of the capacitor stages are defective or missing.	Check if capacitors are energized after switching.
		Current transformer is in the wrong place.	Check if the position of current transformer corresponds to the circuit diagram.
7	"I=0" flashes on the display.	Current transformer circuit interrupted or there is no current flowing on the secondary side.	Use ammeter to check current on secondary side of CT. (I min \geq 0.02A).
		The current flowing on the secondary side of the CT is too small.	(I min \geq 0.02A) Install smaller current transformer.
		Current transformer is defective.	Check the current transformer.

Pos.	Faults	Possible Causes	Necessary Action
8	Despite inductive load no stages are switched on when relay is in automatic mode.	When programming the control relay, the c/k factor, switching time delay, or discharge time have been set too high.	Check programming of the control relay and change if necessary.
		In automatic operation the c/k factor was not correctly detected.	Check the control circuit according to the circuit diagram and repeat the automatic test procedure.
		A different current measuring meter (e.g. ammeter) has been connected in parallel with the control relay to the secondary side of the current transformer.	All measuring instruments in current path must be connected in series
		The capacitor stages are too wide.	Finer adjustment of the capacitor stages is required.
9	In automatic mode one stage is continually switched on or off (hunting).	The c/k factor was set too low.	Set c/k value correctly according to Table 3.
		High load change; The delay time was set too low.	Set higher delay time.
10	The "power factor (cos phi)" display is less than the target power factor although the control relay has switched on all stages	Mode of connection incorrectly programmed.	Reset mode of connection.
		Fault in control circuit.	Check whether the capacitor contactors have been activated.
		Fault in capacitor circuit.	Check the fuses and contacts of the capacitor contactors and perhaps current absorption. Measure the current of each capacitor stage with a clamp-on current meter.
		System undersized.	Press "Set" button and read the shortage of power from the display.
		Failure in automatic adjustment.	Repeat identification process.
11	Control relay does not switch off all stages during times of low load or facility shut-down.	c/k factor is set too high.	Set c/k factor according to Table 3.
		Control relay is in manual mode.	Press "Man" button.

Version V2.10 ab SV